













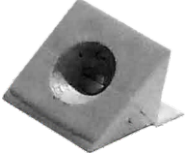







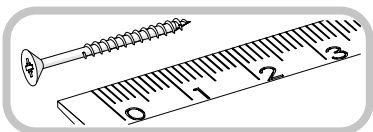

Code	Dimensions				Package
	812	494	16	1	
001	812	494	16	1	2/2
002	900	420	16	1	2/2
003	900	420	16	1	2/2
004	866	398	16	1	1/2
005	818	419	16	1	2/2
006	818	419	16	1	2/2
007	818	397	16	1	1/2
008	812	344	16	1	1/2
009	500	377	16	2	2/2
010	362	494	16	1	2/2
011	384	419	16	1	1/2
012	384	419	16	1	1/2
013	368	397	16	1	2/2
014	368	377	16	1	1/2
015	350	377	16	2	1/2
016	362	344	16	1	1/2
017	866	398	16	1	1/2
018	316	419	16	1	1/2
019	316	419	16	1	1/2
020	835	516	3	1	2/2
021	385	884	3	1	2/2
022	835	367	3	1	2/2
023	884	316	2,5	1	2/2
Accessories				1	1/2

Accessories:

<p>8x a311.60.919</p> 	<p>8x b218</p> 	<p>6x e1 Ø7x50</p> 	<p>36x f1 Ø8x30</p> 
<p>1x f3</p> 	<p>12x l2</p> 	<p>5x k311.054</p> 	<p>4x m30.1</p> 
<p>1x n14</p> 	<p>8x n260.01</p> 	<p>1x p17 Ø6x50</p> 	<p>66x p25 Ø3.5x16</p> 
<p>38x r1 15x12</p> 	<p>8x r10 Ø7x34</p> 	<p>22x r16 Ø7x24</p> 	<p>38x s2</p> 
<p>16x d1 Ø5x16</p> 	<p>1x z1</p> 		



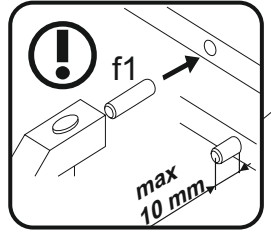
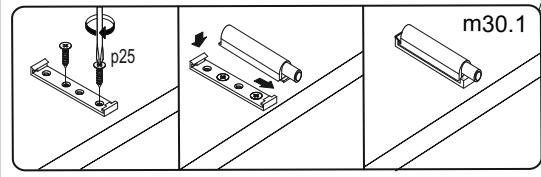
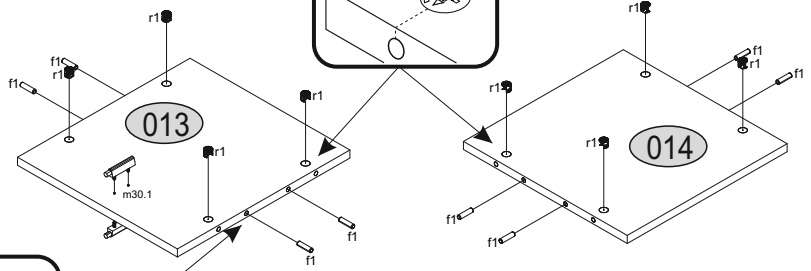
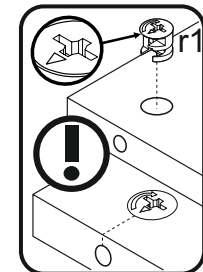
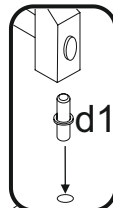
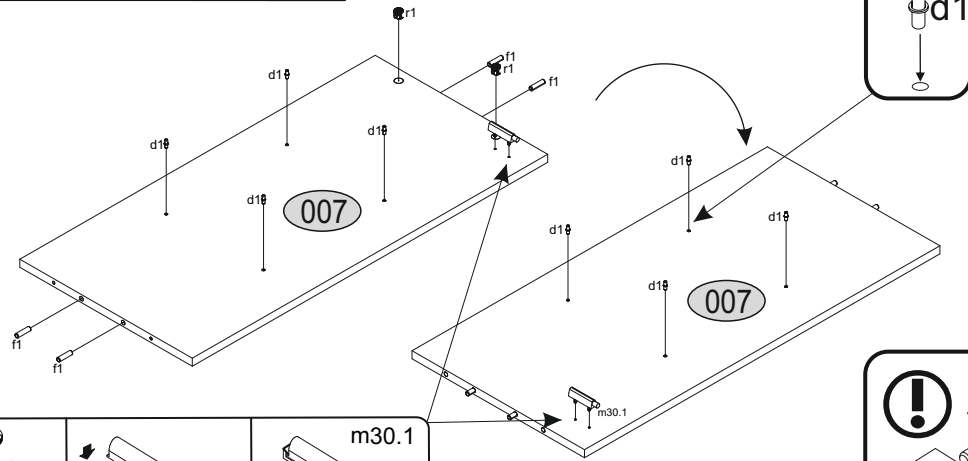

1

f1 	r1 	d1 	m30.1 	p25 
x12	x10	x8	x4	x8



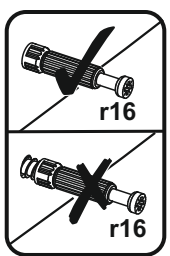
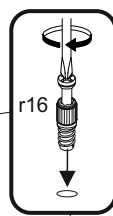
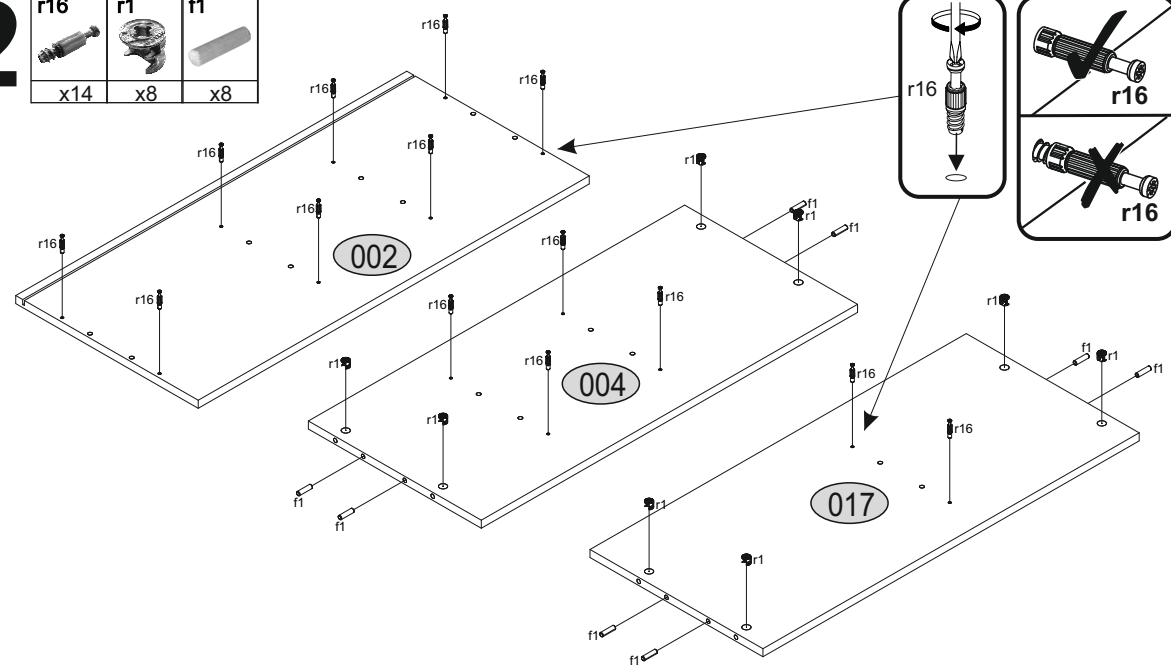

2

r16 	r1 	f1 
x14	x8	x8



3

r16 	r1 
x4	x8

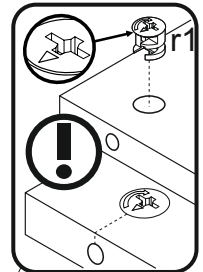
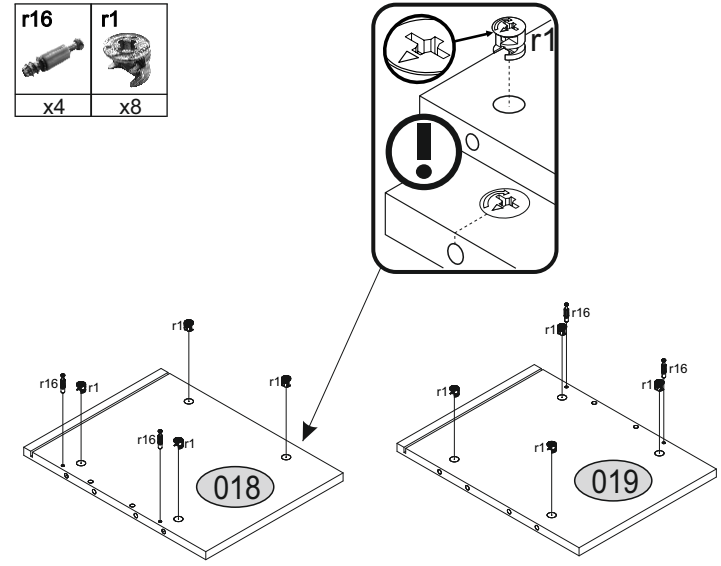

4

f1 	r1 	d1 	b218 	r16
x16	x12	x8	x8	x4

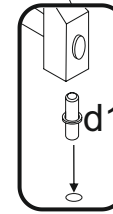
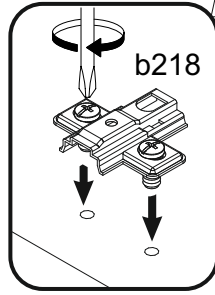
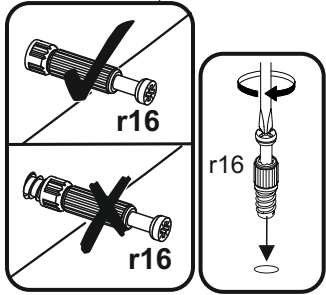
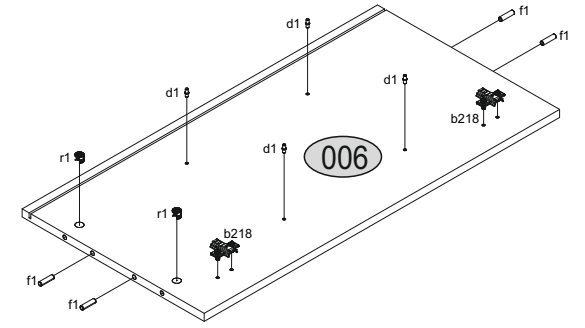
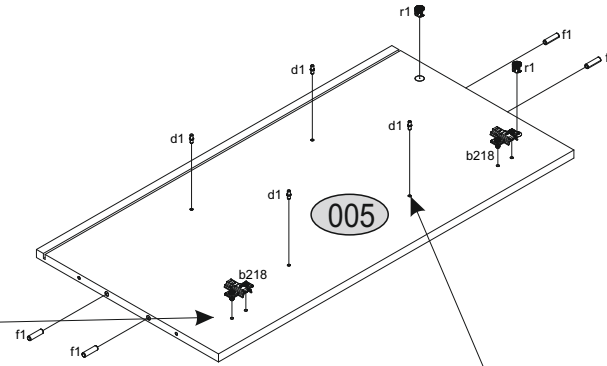
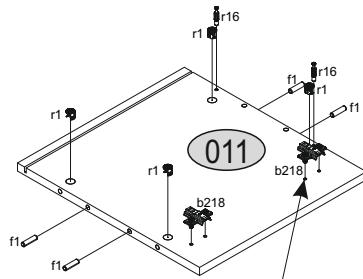
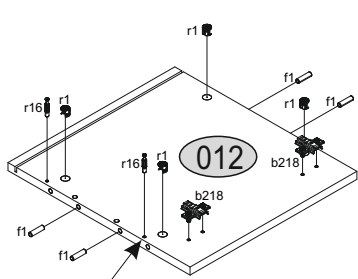

5

p25 	a311.60.919 	m30.1
x16	x8	x4

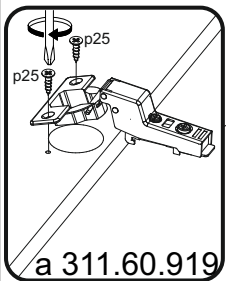
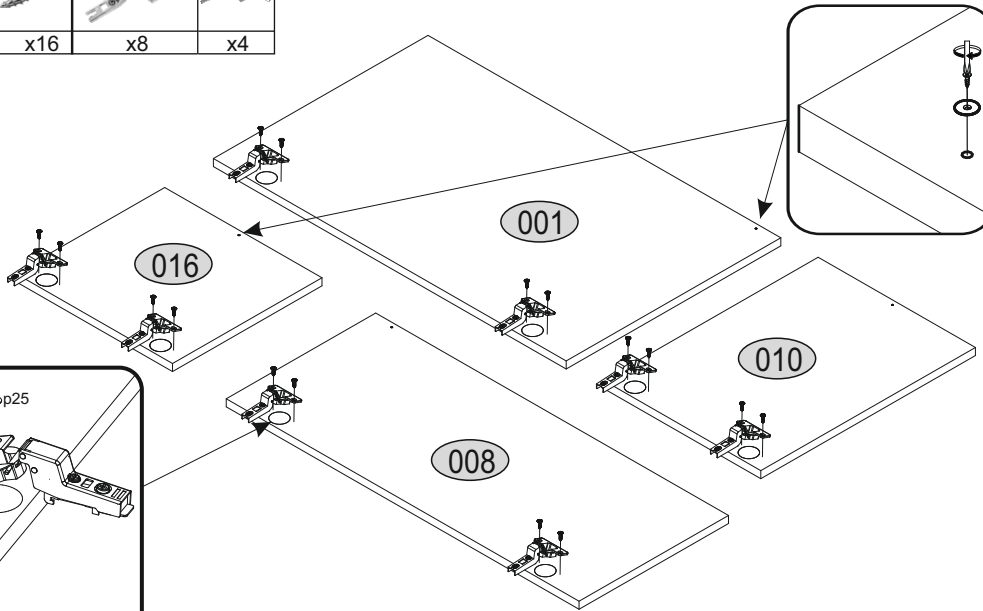

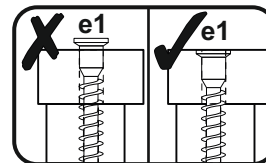
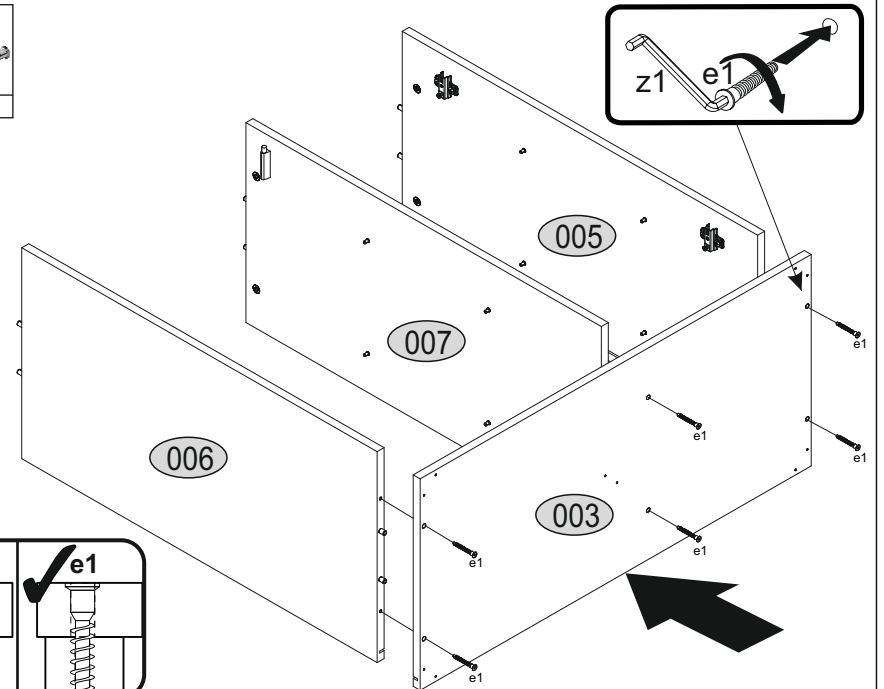

6

e1
x6



7

p25 	k311.054 
x20	x5

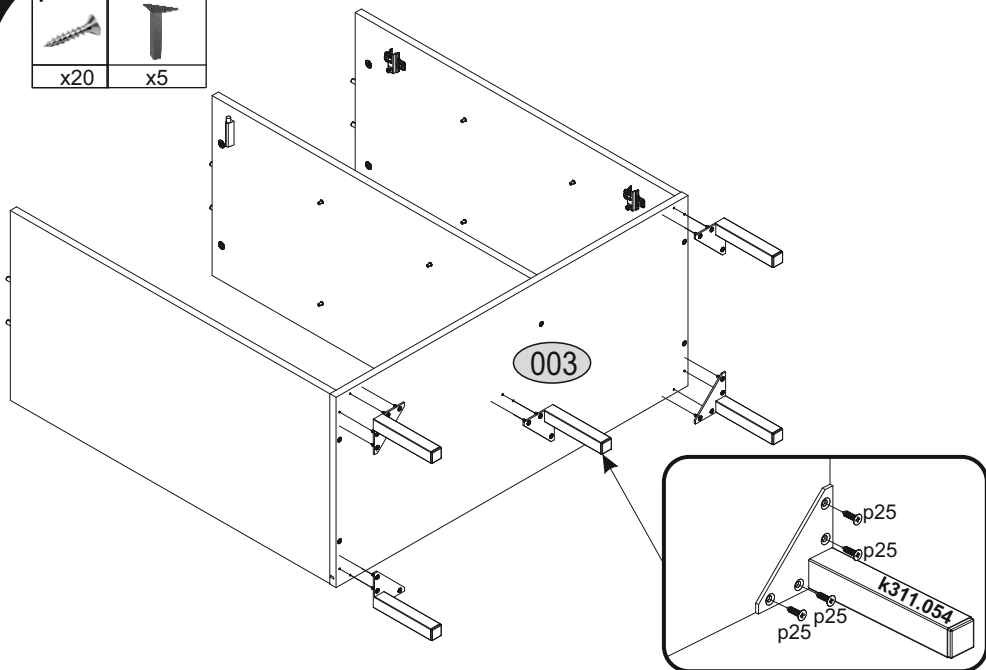

8

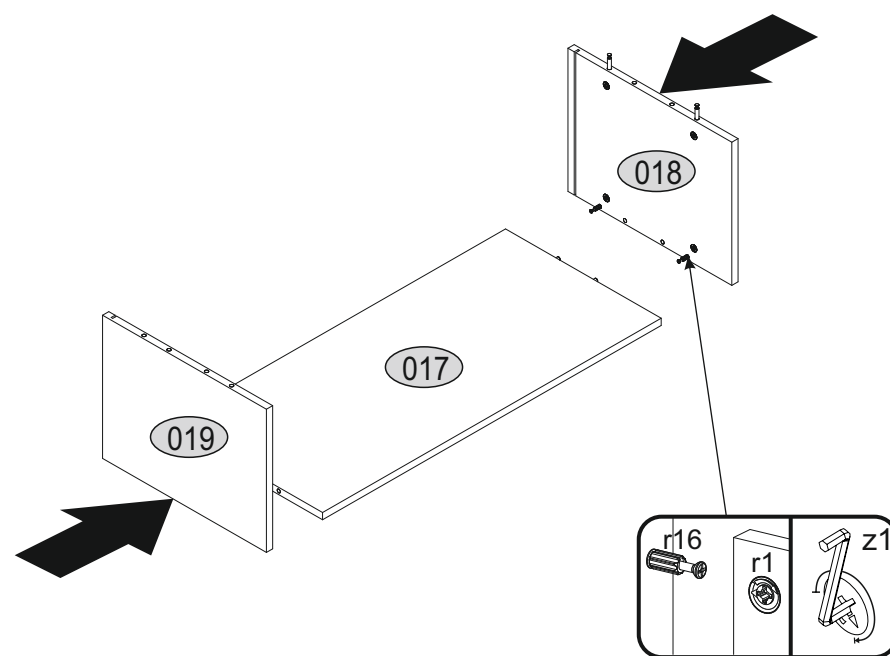

9

r10 
x4

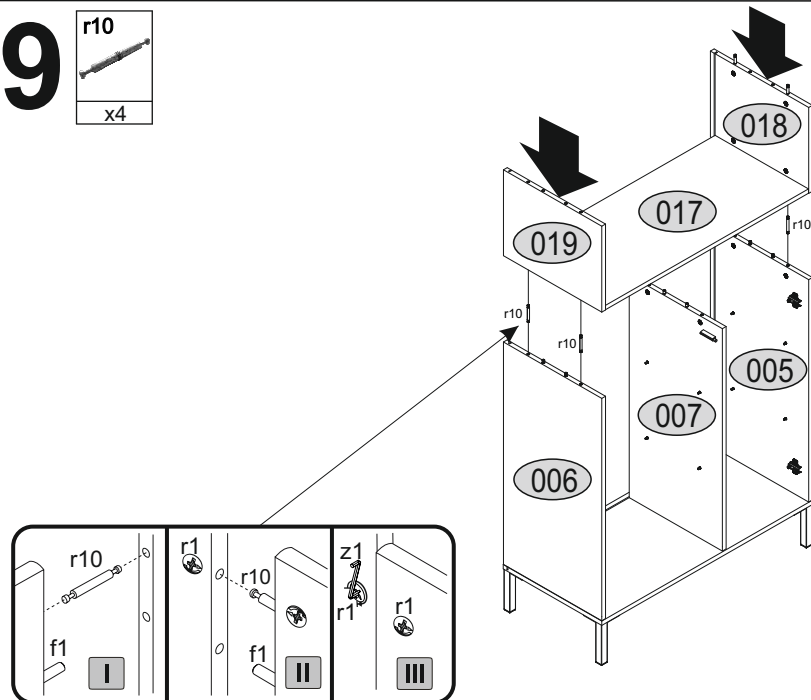

10

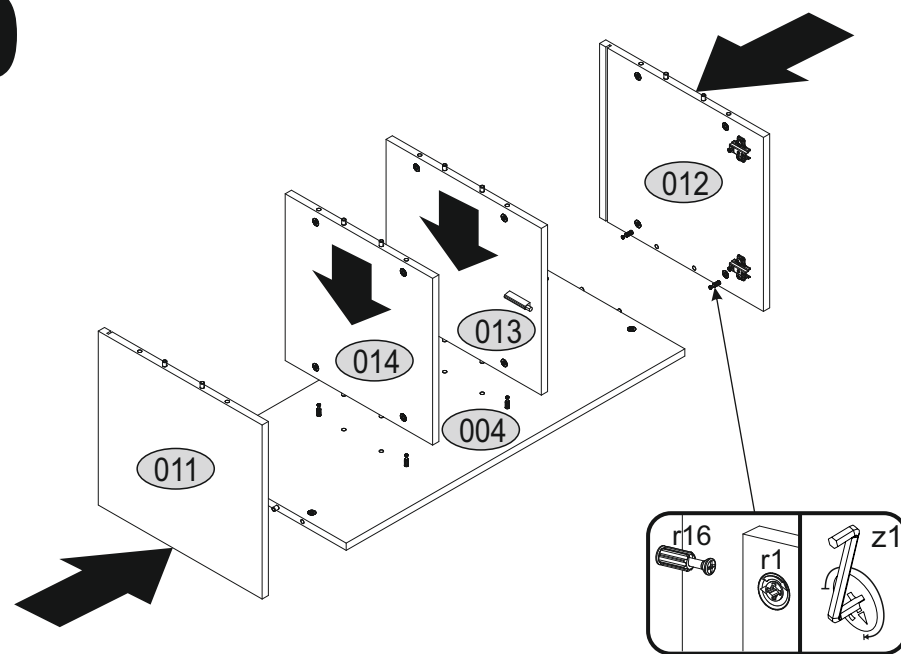

11

r10
x4

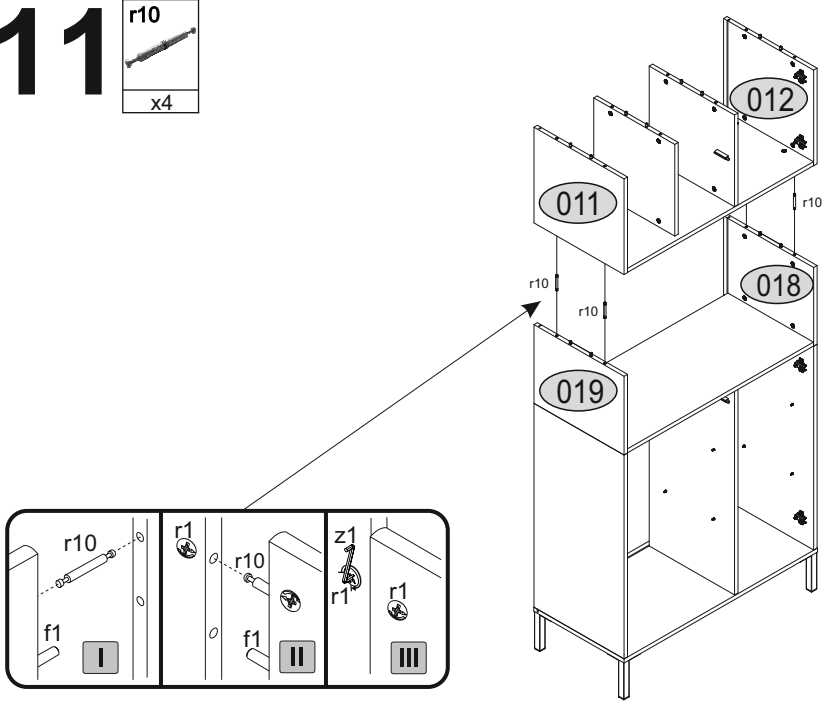

12

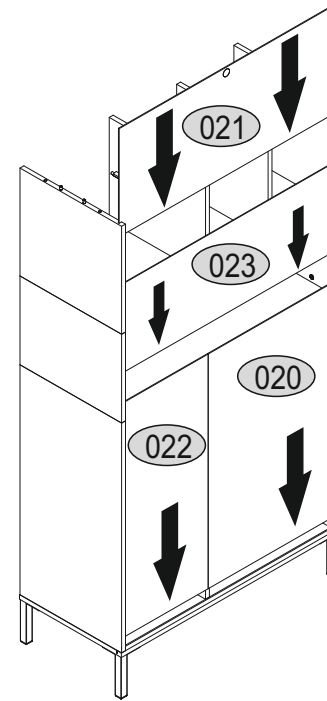

13

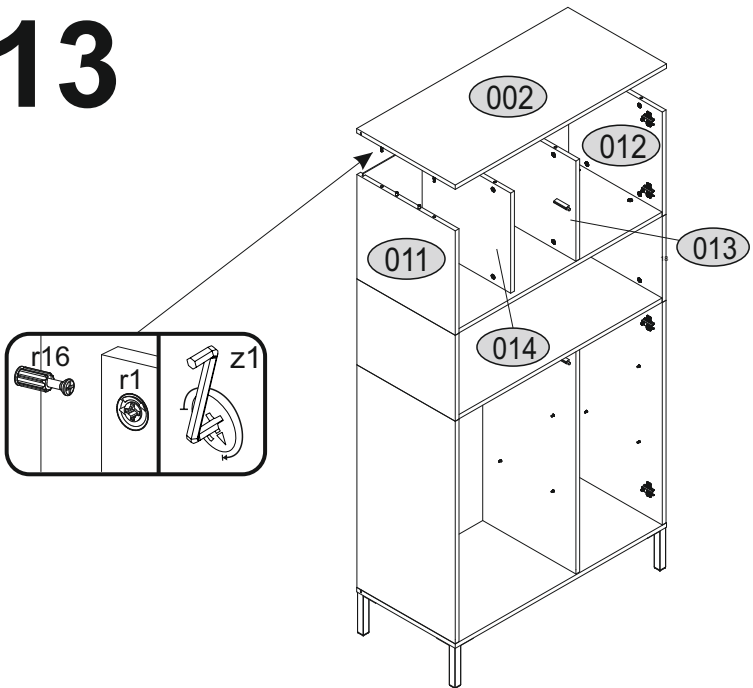

14

p17	p25	n14	n260.01	l2	f3
x1	x22	x1	x8	x12	x1

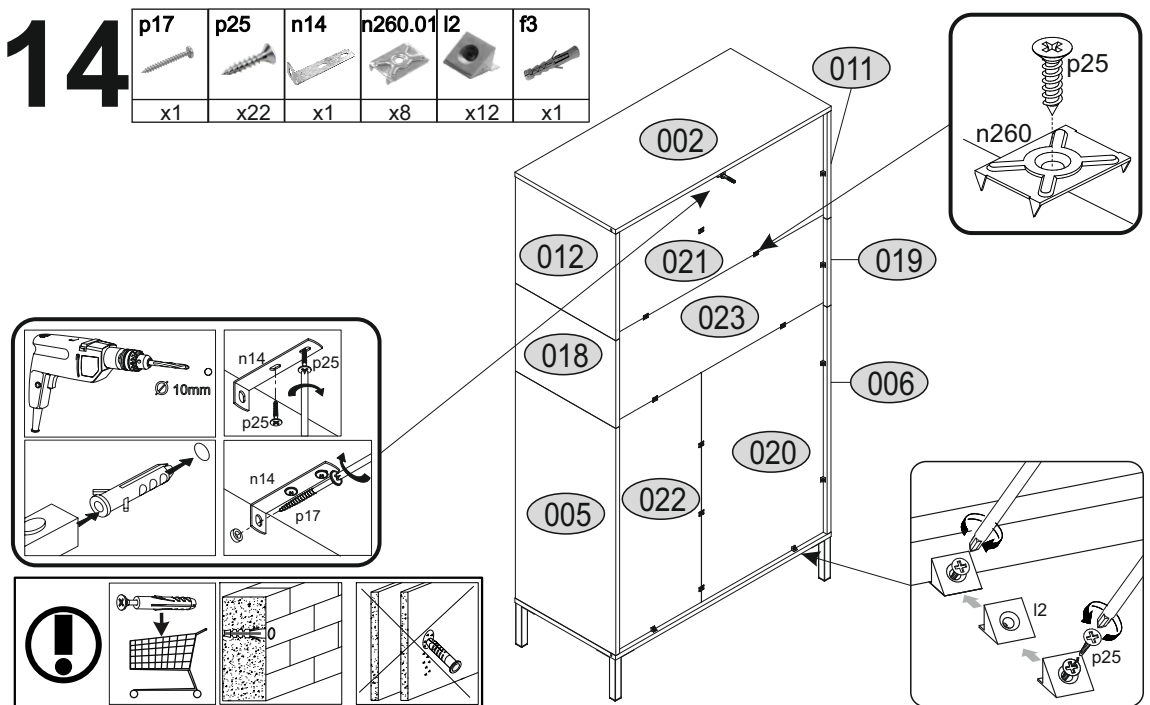

15

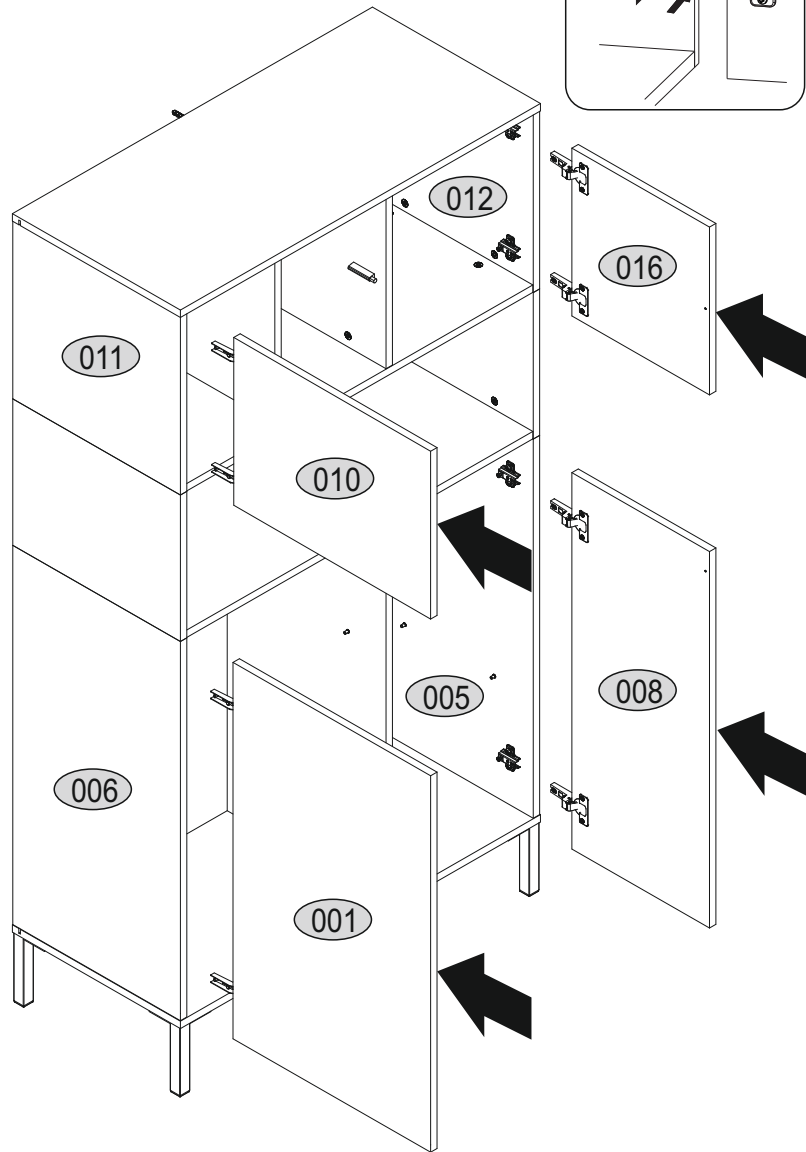
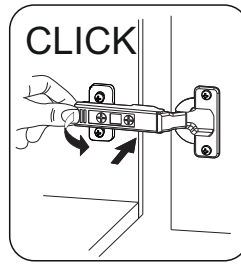

16

